

PQ05RF2/21/2V Series

2A Output, Low Power-Loss Voltage Regulators

■ Features

- Low power-loss (Dropout voltage: MAX. 0.5V)
- Compact resin full-mold package.
- Built-in ON/OFF control terminal (PQ05RF2/PQ05RF21 series)
- Built-in output voltage minute adjustment terminal (ripple rejection is improved) (PQ05RF2V series)

■ Model Line-ups

Output voltage	5V Output	9V Output	12V Output	15V Output
Output voltage precision:±5%	PQ05RF2	PQ09RF2	PQ12RF2	PQ15RF2
Output voltage precision:±2.5%	PQ05RF21	PQ09RF21	PQ12RF21	PQ15RF21
Minute adjustment (Output voltage adjustment range:±10%)	PQ05RF2V	PQ09RF2V	PQ12RF2V	PQ15RF2V

■ Applications

- Series power supply for various electronic equipment such as VCRs, electronic music instruments

■ Equivalent Circuit Diagram

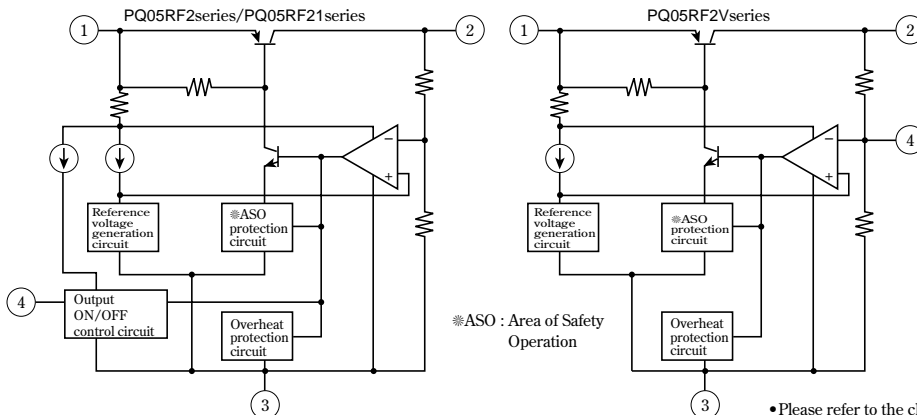

■ Outline Dimensions

(Unit : mm)

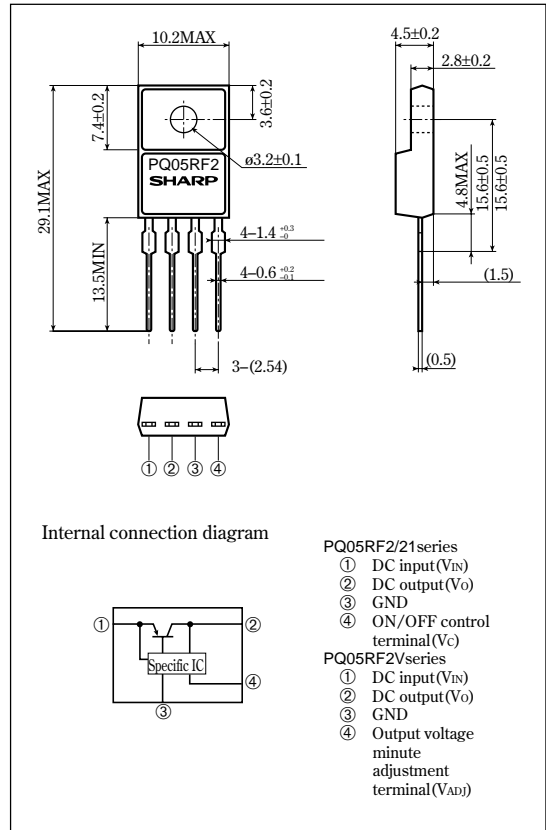

• Please refer to the chapter " Handling Precautions ".

SHARP

Absolute Maximum Ratings

(T_a=25°C)

Parameter	Symbol	Rating	Unit
*1 Input voltage	V _{IN}	35	V
*1 ON/OFF control terminal voltage	PQ05RF2 series	35	V
	PQ05RF21 series		
Output current	I _o	2	A
Power dissipation (No heat sink)	P _{D1}	1.5	W
Power dissipation (With infinite heat sink)	P _{D2}	18	W
*2 Junction temperature	T _j	150	°C
Operating temperature	T _{opr}	-20 to +80	°C
Storage temperature	T _{stg}	-40 to +150	°C
Soldering temperature	T _{sol}	260 (For 10s)	°C

*1 All are open except GND and applicable terminals.

*2 Overheat protection may operate at 125<=T_j<=150°C.

Electrical Characteristics

(Unless otherwise specified, condition shall be I_o=1A, T_a=25°C, *3)

Parameter	Symbol	Conditions	MIN.	TYP.	MAX.	Unit	
Output voltage	V _o	-	PQ05RF2/PQ05RF2V	4.75	5.0	5.25	V
			PQ09RF2/PQ09RF2V	8.55	9.0	9.45	
			PQ12RF2/PQ12RF2V	11.4	12.0	12.6	
			PQ15RF2/PQ15RF2V	14.25	15.0	15.75	
			PQ05RF21	4.88	5.0	5.12	
			PQ09RF21	8.78	9.0	9.22	
			PQ12RF21	11.7	12.0	12.3	
Load regulation	R _{egL}	I _o =5mA to 2A	-	0.5	2.0	%	
Line regulation	R _{egI}	*4	-	0.5	2.5	%	
Temperature coefficient of output voltage	TcV _o	T _j =0 to 125°C	-	±0.02	-	%/°C	
Ripple rejection	RR	I _o =0.5A Refer to Fig.2	PQ05RF2/PQ05RF21Series	45	55	-	dB
			PQ05RF2VSeries	55	-	-	
Dropout voltage	V _{f-o}	*5, I _o =2A	-	-	0.5	V	
ON-state voltage for control	V _{C (ON)}	-	2.0 *6	-	-	V	
ON-state current for current	I _{C (ON)}	V _C =2.7V	-	-	20	μA	
OFF-state voltage for control	V _{C (OFF)}	-	-	-	0.8	V	
OFF-state current for control	I _{C (OFF)}	V _C =0.4V	-	-	-0.4	mA	
Quiescent current	I _q	I _o =0	-	-	10	mA	
Output voltage minute adjustment range	V _{o (ADJ)}	-	PQ05RF2V	4.5	5.0	5.5	V
			PQ09RF2V	8.1	9.0	9.9	
			PQ12RF2V	10.8	12.0	13.2	
			PQ15RF2V	13.5	15.0	16.5	

*3 PQ05RF2 Series: V_{IN}=7V, PQ09RF2 Series: V_{IN}=15V, PQ12RF2 Series: V_{IN}=18V, PQ15RF2 Series: V_{IN}=23V

*4 PQ05RF2/PQ05RF21/PQ05RF2V: V_{IN}=6 to 12V PQ09RF2/PQ09RF21/PQ09RF2V: V_{IN}=10 to 25V

PQ12RF2/PQ12RF21/PQ12RF2V: V_{IN}=13 to 29V PQ15RF2/PQ15RF21/PQ15RF2V: V_{IN}=16 to 32V

*5 Input voltage shall be the value when output voltage is 95% in comparison with the initial value.

*6 In case of opening control terminal @, output voltage turns on. (PQ05RF2/PQ05RF21 Series)

Fig. 1 Test Circuit

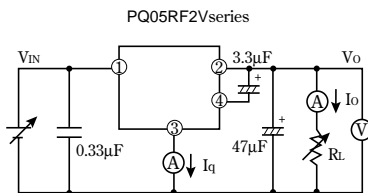
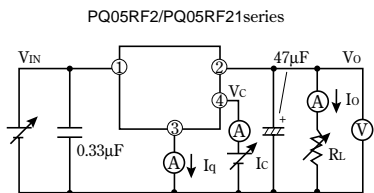

Fig. 2 Test Circuit of Ripple Rejection

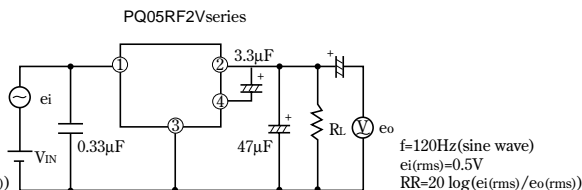
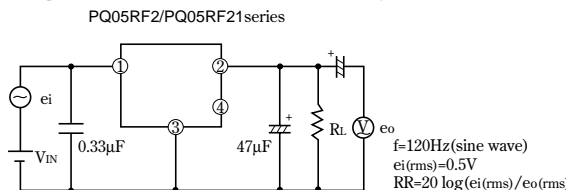
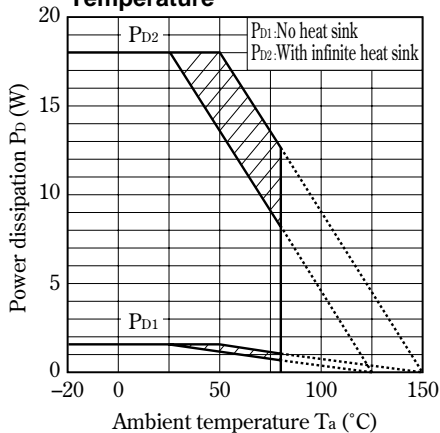

Fig. 3 Power Dissipation vs. Ambient Temperature



Note) Oblique line portion : Overheat protection may operate in this area.

Fig. 4 Overcurrent Protection Characteristics (Typical value)

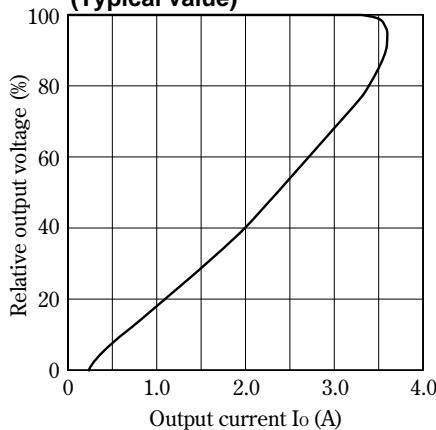

Fig. 5 Output Voltage Minute Adjustment Characteristics (PQ05RF2V)

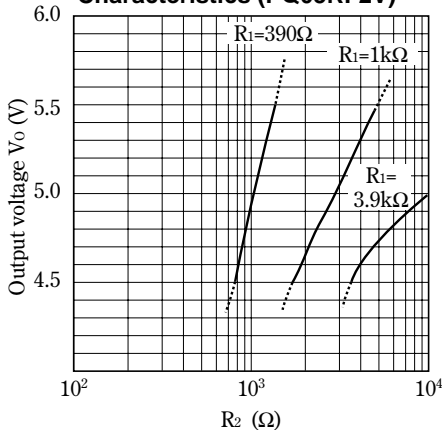

Fig. 6 Output Voltage Minute Adjustment Characteristics (PQ09RF2V)

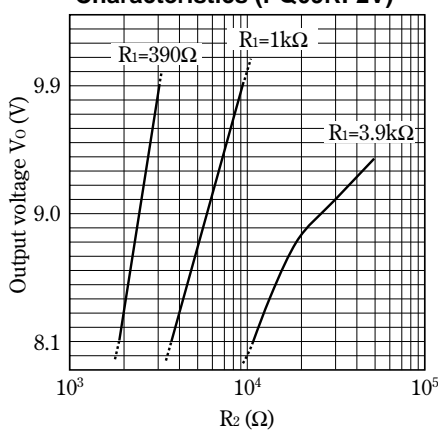

Fig. 7 Output Voltage Minute Adjustment Characteristics (PQ12RF2V)

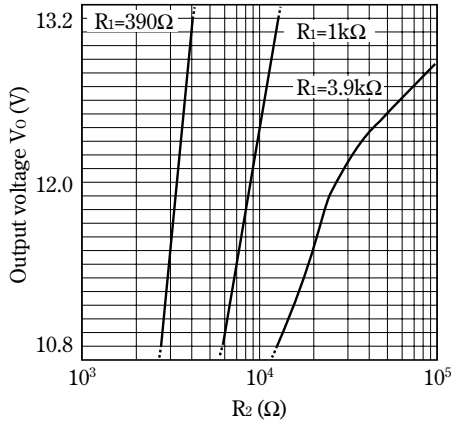

Fig. 8 Output Voltage Minute Adjustment Characteristics (PQ15RF2V)

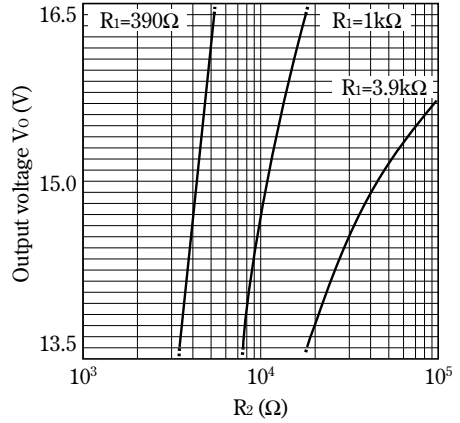

Fig. 9 Output Voltage Deviation vs. Junction Temperature (PQ05RF2/PQ05RF21/PQ05RF2V)

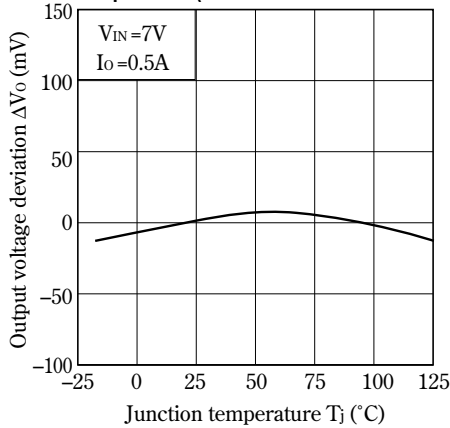

Fig.10 Output Voltage Deviation vs. Junction Temperature (PQ09RF2/PQ09RF21/PQ09RF2V)

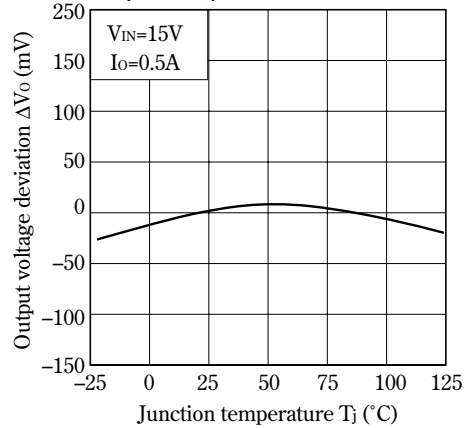

Fig.11 Output Voltage Deviation vs. Junction Temperature (PQ12RF2/PQ12RF21/PQ12RF2V)

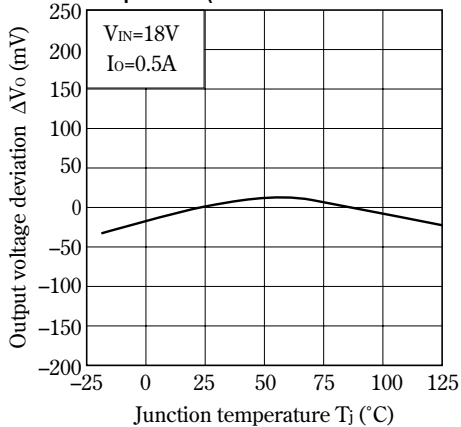

Fig.12 Output Voltage Deviation vs. Junction Temperature (PQ15RF2/PQ15RF21/PQ15RF2V)

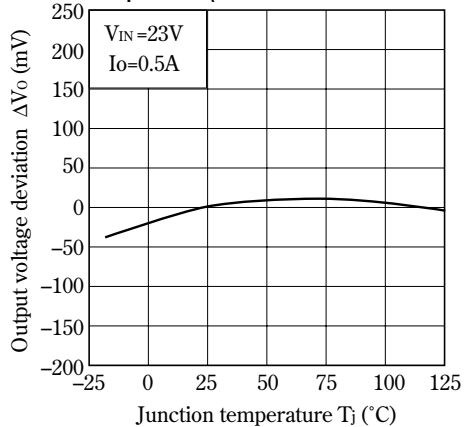

Fig.13 Output Voltage vs. Input Voltage (PQ05RF2/PQ05RF21/PQ05RF2V)

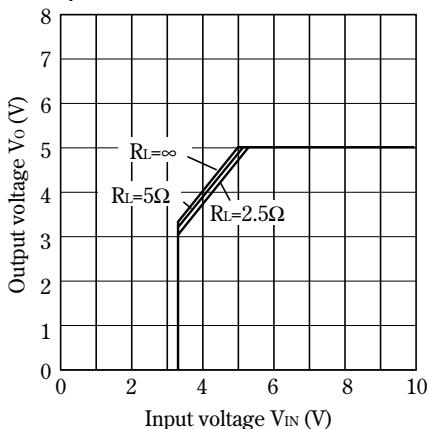

Fig.14 Output Voltage vs. Input Voltage (PQ09RF2/PQ09RF21/PQ09RF2V)

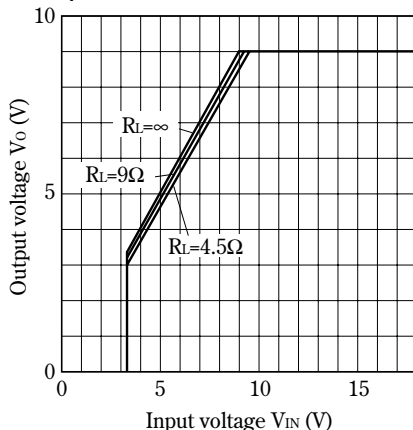

Fig.15 Output Voltage vs. Input Voltage (PQ12RF2/PQ12RF21/PQ12RF2V)

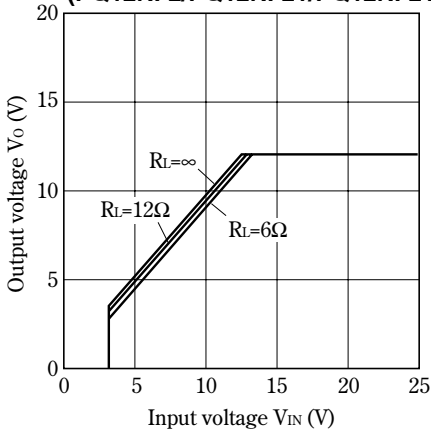

Fig.16 Output Voltage vs. Input Voltage (PQ15RF2/PQ15RF21/PQ15RF2V)

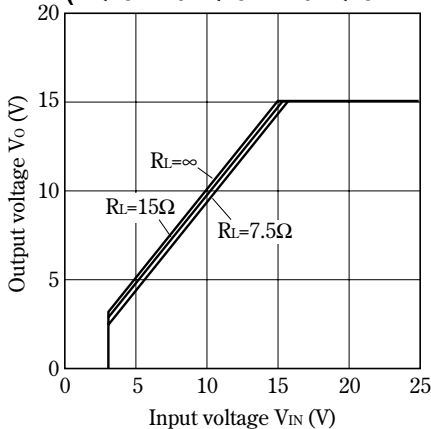

Fig.17 Circuit Operating Current vs. Input Voltage (PQ05RF2/PQ05RF21/PQ05RF2V)

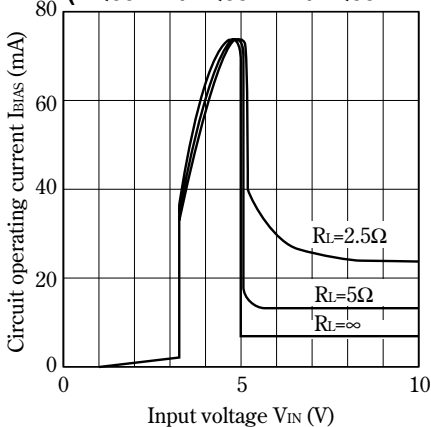

Fig.18 Circuit Operating Current vs. Input Voltage (PQ09RF2/PQ09RF21/PQ09RF2V)

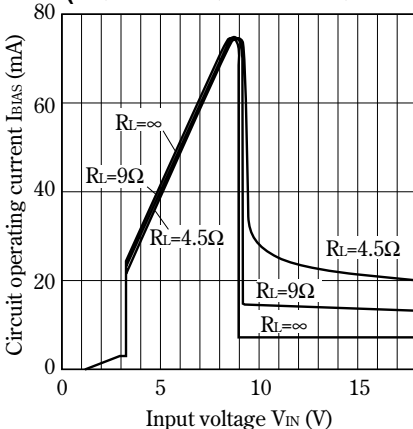

Fig.19 Circuit Operating Current vs. Input Voltage (PQ12RF2/PQ12RF21/PQ12RF2V)

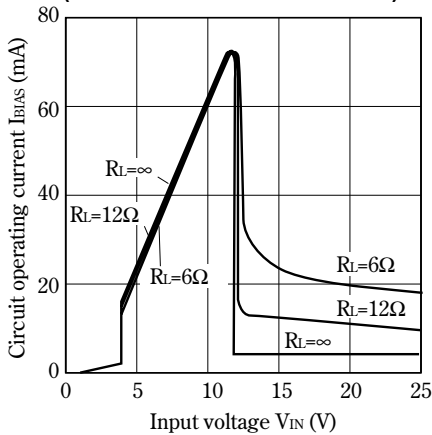

Fig.20 Circuit Operating Current vs. Input Voltage (PQ15RF2/PQ15RF21/PQ15RF2V)

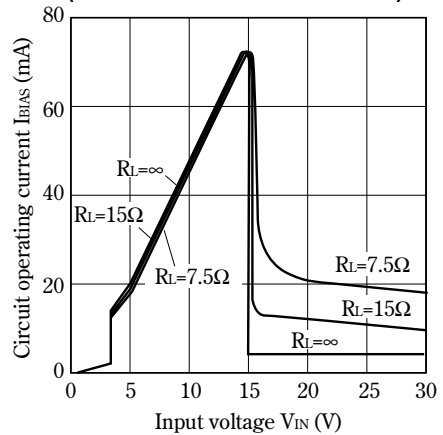

Fig.21 Dropout Voltage vs. Junction Temperature

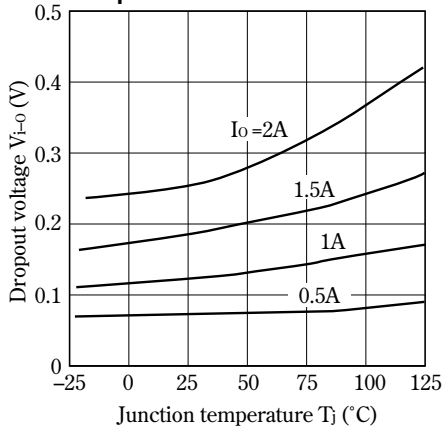

Fig.22 Quiescent Current vs. Junction Temperature

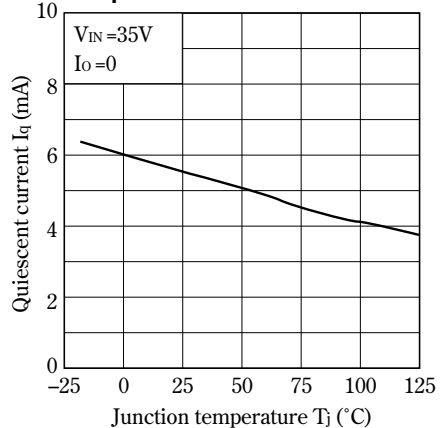

Fig.23 Ripple Rejection vs. Input Ripple Frequency (PQ05RF2/PQ05RF21/PQ09RF2/PQ09RF21/PQ12RF2/PQ12RF21/PQ15RF2/PQ15RF21)

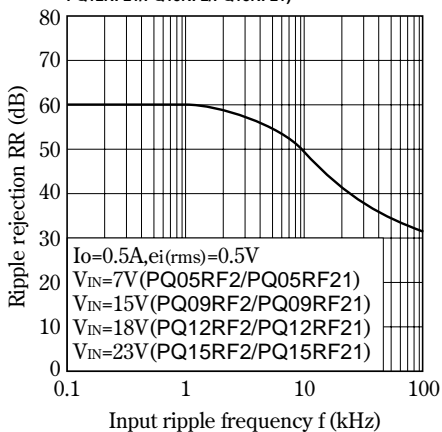

Fig.24 Ripple Rejection vs. Input Ripple Frequency (PQ05RF2V/PQ09RF2V/PQ12RF2V/PQ15RF2V)

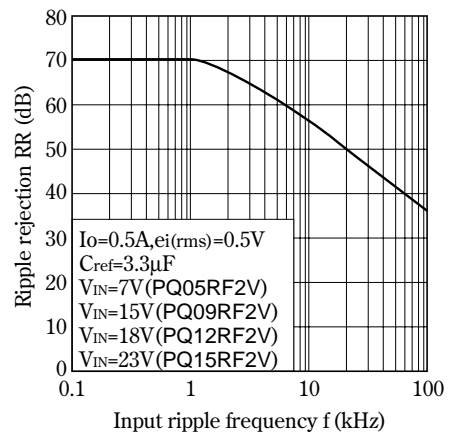
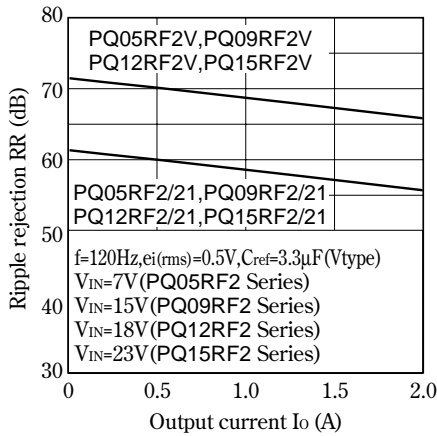
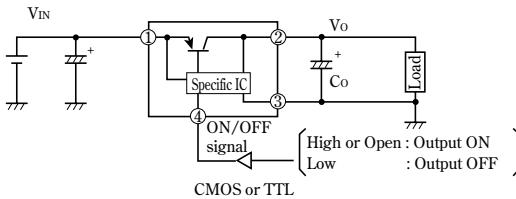

Fig.25 Ripple Rejection vs. Output Current



■ Typical Application

PQ05RF2/PQ05RF21 Series



PQ05RF2V Series

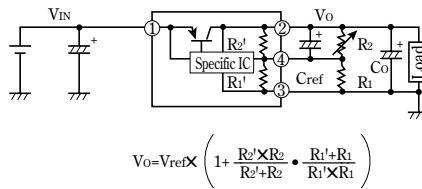

V_{ref} Nearly=1.26V, R_1' Nearly=390Ω
 PQ05RF2V : R_2' Nearly=1.16kΩ
 PQ09RF2V : R_2' Nearly=2.40kΩ
 PQ12RF2V : R_2' Nearly=3.32kΩ
 PQ15RF2V : R_2' Nearly=4.45kΩ

(Note) R_1' and R_2' are built in a specific IC.

■ Model Line-ups for Lead Forming Type

Output voltage	5V Output	9V Output	12V Output	15V Output
Output voltage precision:±5%	PQ05RF2A	PQ09RF2A	PQ12RF2A	PQ15RF2A
Output voltage precision:±2.5%	PQ05RF2B	PQ09RF2B	PQ12RF2B	PQ15RF2B

Outline Dimensions (PQ05RF2A/PQ05RF2B Series)

(Unit : mm)

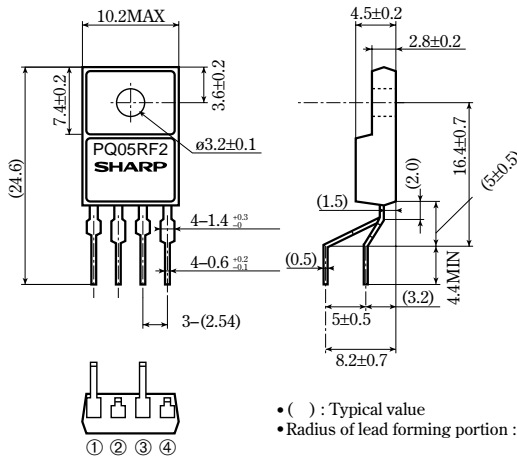

- () : Typical value
- Radius of lead forming portion : R=0.5 to 1.5mm

Internal connection diagram

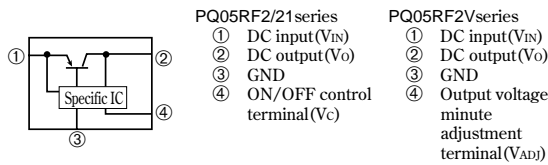

Note) The value of absolute maximum ratings and electrical characteristics is same as ones of PQ05RF2/21series.

Precautions for Use

(1) Minute adjustment of output voltage (PQ05RF2V series)

If the external resistor is attached to the terminals ②, ③ and ④, minute adjustment of output voltage is possible. (Refer to the example of basic circuit (PQ05RF2V series) and Fig.5 to 8.)

NOTICE

- The circuit application examples in this publication are provided to explain representative applications of SHARP devices and are not intended to guarantee any circuit design or license any intellectual property rights. SHARP takes no responsibility for any problems related to any intellectual property right of a third party resulting from the use of SHARP's devices.
- Contact SHARP in order to obtain the latest device specification sheets before using any SHARP device. SHARP reserves the right to make changes in the specifications, characteristics, data, materials, structure, and other contents described herein at any time without notice in order to improve design or reliability. Manufacturing locations are also subject to change without notice.
- Observe the following points when using any devices in this publication. SHARP takes no responsibility for damage caused by improper use of the devices which does not meet the conditions and absolute maximum ratings to be used specified in the relevant specification sheet nor meet the following conditions:
 - (i) The devices in this publication are designed for use in general electronic equipment designs such as:
 - Personal computers
 - Office automation equipment
 - Telecommunication equipment [terminal]
 - Test and measurement equipment
 - Industrial control
 - Audio visual equipment
 - Consumer electronics
 - (ii) Measures such as fail-safe function and redundant design should be taken to ensure reliability and safety when SHARP devices are used for or in connection with equipment that requires higher reliability such as:
 - Transportation control and safety equipment (i.e., aircraft, trains, automobiles, etc.)
 - Traffic signals
 - Gas leakage sensor breakers
 - Alarm equipment
 - Various safety devices, etc.
 - (iii) SHARP devices shall not be used for or in connection with equipment that requires an extremely high level of reliability and safety such as:
 - Space applications
 - Telecommunication equipment [trunk lines]
 - Nuclear power control equipment
 - Medical and other life support equipment (e.g., scuba).
- Contact a SHARP representative in advance when intending to use SHARP devices for any "specific" applications other than those recommended by SHARP or when it is unclear which category mentioned above controls the intended use.
- If the SHARP devices listed in this publication fall within the scope of strategic products described in the Foreign Exchange and Foreign Trade Control Law of Japan, it is necessary to obtain approval to export such SHARP devices.
- This publication is the proprietary product of SHARP and is copyrighted, with all rights reserved. Under the copyright laws, no part of this publication may be reproduced or transmitted in any form or by any means, electronic or mechanical, for any purpose, in whole or in part, without the express written permission of SHARP. Express written permission is also required before any use of this publication may be made by a third party.
- Contact and consult with a SHARP representative if there are any questions about the contents of this publication.